



# **INSTALLATION, MAINTENANCE AND USE INSTRUCTIONS FOR FREE-STANDING COOKERS**

**MAS  
HER  
PRO**

**READ THE INSTRUCTION BOOKLET BEFORE INSTALLING AND USING THE  
APPLIANCE.**

**The manufacturer will not be responsible for any damage to property or to persons caused by  
incorrect installation or improper use of the appliance.**

The manufacturer is not responsible for any inaccuracies, due to printing or transcription errors, contained in  
this booklet. In addition, the appearance of the figures reported is also purely indicative.

The manufacturer reserves the right to make changes to its products when considered necessary and useful,  
without affecting the essential safety and operating characteristics.

3100729

## CONTENTS:

INSTALLER TECHNICAL MANUAL.....	pg.2
APPLIANCE MAINTENANCE .....	pg.4
INSTALLING A RANGE COOKER .....	pg.5
INDUCTION .....	pg.8
SEPARATE GRILL COMPARTMENT (triple oven cavity models only).....	pg.12
OVEN.....	pg.14
USING THE AUTOMATIC PROGRAMMER.....	pg.18
OVEN TEMPERATURE GUIDE.....	pg.22
USING THE THERMOMETER.....	pg.24
CLEANING YOUR COOKER .....	pg.25
ACCESSORIE.....	pg.28
TROUBLESHOOTING.....	pg.29
USEFUL TIPS.....	pg.30

**THIS APPLIANCE HAS BEEN DESIGNED FOR NON-PROFESSIONAL DOMESTIC USE.**

## INSTALLER TECHNICAL MANUAL

This appliance is marked according to the European directive 2011/65/EU (RoHS)



This appliance is marked according to the European directive 2012/19/EU on Waste Electrical and Electronic Equipment (WEEE).

This guideline is the frame of a European-wide validity of return and recycling on Waste Electrical and Electronic Equipment.

The symbol on the product indicates that this product may not be treated as household waste. Instead it shall be handed over to the applicable collection point for the recycling of electrical and electronic equipment.

Disposal must be carried out in accordance with local environmental regulations for waste disposal. For more detailed information about treatment, recovery and recycling of this product, please contact your local city council office.

Warning: If the surface is cracked, switch off the appliance to avoid the possibility of electric shock

The appliance and its accessible parts become very hot during use. Care must be careful not to touch the heating elements. Children under 16 years old must be kept away if not constantly supervised.

This appliance can be used by persons with reduced physical, sensory or mental capabilities, provided that they are supervised by someone who understands the use instructions and the risks involved.

Do not use steam cleaners for cleaning

Caution: make sure the appliance is switched off before replacing the bulb to prevent possibility of electric shock

Use only the recommended thermal probe for this oven.

For cookers with electric ovens

ATTENTION: The accessible parts can become hot during use. Keep children away from the appliance.

For glass doors: Do not use abrasive cleaning products or metal spatulas with sharp edges to clean the glass of the oven door since this could scratch the surface and the glass could break.

If the power supply cord is damaged, it must be replaced by the manufacturer, its service agent or similar qualified person in order to avoid a hazard.

### Installer information

The installation, all adjustments, transformations and maintenance listed in this part of the manual must be carried out only by skilled personnel. Improper installation may cause damage to persons, animals or property, for which the manufacture will not be held responsible. The appliance safety or automatic adjustment devices may be changed during the service life of the system only by the manufacturer or by the duly authorised supplier.

### Installing the cooker

After having removed the various loose parts from the internal and external packing, make sure that the cooker is not damaged. In case of doubt, do not use the appliance and contact skilled personnel.

**Keep all the dangerous packing parts (polystyrene foam, bags, cardboard, staples, etc.) away from children.**

The appliance can be installed as a freestanding unit, next to a wall at a distance of less than 20mm (Fig.1B, Class 1 Installation) or inserted between two walls (see Fig.1A, Class 2 Subclass 1 Installation). A single sidewall that exceeds the height of the work surface is possible. This must be at a minimum distance of 70 mm from the edge of the cooker (see Fig.1B, Class 1 Installation).

Any walls of the adjacent furniture pieces and the wall behind the cooker must be made with heat-resistant material that can withstand a minimum over temperature of 65 K.

**WARNING: the connection to the gas network must only use metal flexible pipes that conform with the national standards in force.**

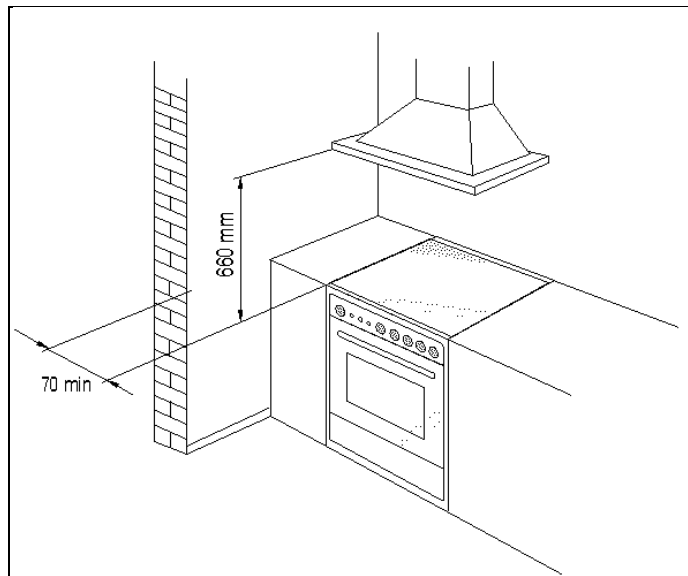

Fig.1A

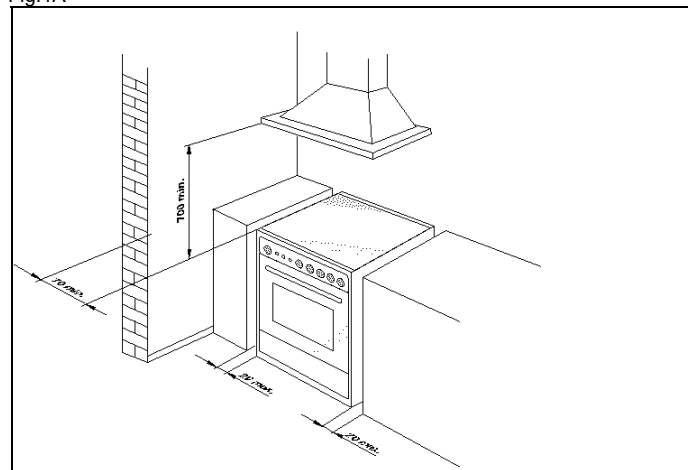

Fig.1B

# APPLIANCE MAINTENANCE

## ATTENTION: IMPORTANT WARNINGS

### For cookers resting on a base

ATTENTION: If the cooker rests on a base, take the measures necessary to prevent the cooker from sliding along the support base.

### For cookers with electric ovens

The unit becomes hot during use. Do not touch the heating elements inside the oven.

### For cookers with electric ovens

ATTENTION: The accessible parts can become hot during use. Keep children away from the appliance.

### For the food warmer compartment (or drop leaf in our case)

ATTENTION: The internal parts of the food warmer can become hot during use.

### For glass doors

Do not use abrasive cleaning products or metal spatulas with sharp edges to clean the oven door's glass since this could scratch the surface and the glass could break.

**Do not use steam cleaners to clean the appliance.**

### Replacing parts

Before performing any maintenance operation, disconnect the appliance from the gas supply and electricity network.

To replace parts such as knobs and burners, just remove them from the seats without disassembling any part of the cooker.

To replace the oven bulb, just unscrew the protection cap that projects out inside the oven.

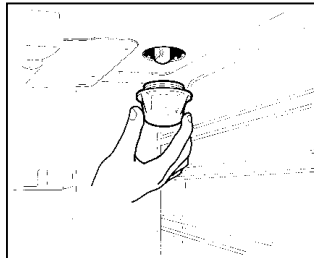

Fig.2

**WARNING:** Before replacing the bulb, disconnect the appliance from the electric power supply.

**WARNING:** The power cord supplied with the appliance is connected to that appliance with an X type connection (in compliance with standards EN 60335-1, EN 60335-2-6 and subsequent amendments) for which it can be installed without the use of special tools, with the same type of cord as the one installed.

If the power cord becomes worn or damaged, replace it based on the information reported in types of power cords paragraph .

**WARNING:** If the power cord is replaced, the installer shall ensure that the ground cable is longer than the phase cables and also shall comply with the warnings regarding the electric connection.

To replace the power cable, lift the terminal board's cover and replace the cable. To access the terminal board in cookers with a 3x2.5mm<sup>2</sup> cable, the back panel on the rear of the appliance must be removed. The power cord should be replaced only by qualified personnel.

Before disposing of the packaging, please ensure you have removed all the components.

The up-stand is packed separate and is taped to the back of the cooker. Other components can be found inside the ovens. All packaging and covering films must be removed before the installation can commence.

All electric cookers should be installed by a qualified electrician in accordance with IEE regulations and local electricity provider rules. Building regulations must be considered when undertaking any installation. Failure to install the appliance correctly will render the warranty null and void.

Range cookers are heavy and should be handled by two people. Never lift or drag a range by the oven handles as damage may occur.

Note: Pictures and graphics in this manual cover different models and may vary in minor details from your cooker.

## INSTALLING RANGE COOKER

### Rating of Services

The rating plate is visible in the storage area of the cooker and a copy is also attached to last page of the user manual.

Before connecting the cooker, check that the requirements on the rating plate correspond with those of the electrical system and gas supply (where applicable). Ensure that the electrical system and isolating switches have a suitable capacity to carry the maximum power as indicated on the rating plate. This chart can be used as a guide to the electrical supply ratings.

Cooker model	220-240 V~	380-415 V2N ~	380-415 V3N ~
90x60 single oven Induction hob top	3x10 mm <sup>2</sup>	4x4 mm <sup>2</sup>	5x1,5 mm <sup>2</sup>
90x60 twin oven Induction hob top	3x6 mm <sup>2</sup>	4x4 mm <sup>2</sup>	5x2,5 mm <sup>2</sup>
100x60 / 110x60 twin oven Induction hob top	3x6 mm <sup>2</sup>	4x4 mm <sup>2</sup>	3x2,5 mm <sup>2</sup>
100x60 3 oven compartments Induction hob top	3x10 mm <sup>2</sup>	4x4 mm <sup>2</sup>	3x2,5 mm <sup>2</sup>

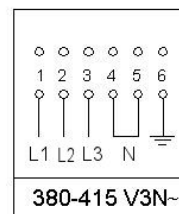
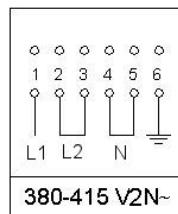
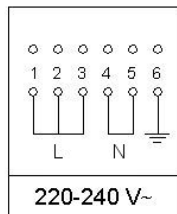

### Positioning

The cooker may be installed in a kitchen or open-plan kitchen diner but not in a room containing a bath or shower. The cooker should be positioned in an area with good light and free from draughts.

Any shelf or unit of combustible material should be at least 660mm above the hotplate. In addition an area of 75mm wide on either side and behind the hotplate must be clear of any combustible materials to a height of 400mm. Units must not overhang over the hob.

Kitchen cabinets may be fitted flush to the sides of the cooker, but to allow for cleaning and servicing

It is recommended that a 2.5mm gap be allowed on each side so that the cooker may be moved if necessary.

The worktop or kitchen cabinets must not protrude beyond the height of the cooker hotplate frame.

### Ventilation

Your appliance is not connected to a combustion products evacuation device. The room in which it is to be installed must have an air supply in accordance with national standards. The room must have an opening window or equivalent, and some rooms may require a permanent vent in addition to the opening window. General guidelines: The cooker must not be installed in a bedroom of 20m<sup>3</sup> or less. If the cooker is installed in a room with a volume of less than 5m<sup>3</sup>, then a vent

with an effective area of 100cm<sup>3</sup> is required. If it is installed in a room with a volume of between 5m<sup>3</sup> and 10m<sup>3</sup>, then an air vent with an effective area 50cm<sup>3</sup> is necessary. If there are other fuel burning appliances in the room, please consult national standards for guidance.

### Electrical connection

The electric connection must comply with the current legal standards and regulations.

Before making the connection, check that:

- The system electrical rating and the current outlets are adequate for the maximum power output of the appliance (see the rating plate applied to back of the cooker).
- The outlet or the system is equipped with an efficient ground connection in accordance with the current legal standards and regulations. The company will not be responsible for the non-compliance with these instructions.

**letter L or L1 (phase)** = brown wire;

**letter L2 (phase)** = black wire;

**letter L3 (phase)** = grey wire;

**letter N (neutral)** = blue wire;

**ground symbol**  = green-yellow wire;

- The power cord must be positioned so that an over temperature of 75 K will not be reached at any point.
- Do not use reductions, adapters or splitters since they might cause false contacts and lead to dangerous overheating.

When the connection is made directly to the electric network:

- Use a device that ensures disconnection from the mains in which the contacts are opened to a distance that permits complete disconnection according to the conditions for over-voltage category III.
- Remember that the ground wire must not be interrupted by the circuit-breaker.
- As an alternative, the electric connection can also be protected by a high-sensitivity residual current circuit-breaker.
- It is highly recommended to attach the special green-yellow ground wire to an efficient ground system.

WARNING: If the power cord is replaced, the ground wire (yellow-green) connected to the terminal, should be longer than the other wires by about 2 cm.

WARNING: The power cord should be replaced only by qualified personnel.

### Types of power cords

The appliance is equipped with a terminal for the electric connection placed behind, which is accessible by removing the posterior casing.

The power supply cable is suitable for appliance operating on 220-240 V~

**ATTENTION: The appliance conforms with the regulations of directives 2009/142/CE (Gas Directive) regarding gas appliances for domestic use and the like, 2006/95/CE (Low Voltage Directive) regarding electrical safety and 2004/108/CE, (EMC Directive) regarding electromagnetic compatibility.**

Ensure that the electricity supply is switched off before making the connection. This appliance must be earthed.

Connection to the electricity supply must be made through the flex cable that is already attached to the rear of the cooker. The end of the cable is tucked into the cooker storage area.

Connection to the supply must be made through fixed wiring. It cannot be connected to a normal domestic power socket. A double pole switched cooker box should be used with contact separation of at least 3mm.

Turn on each hob zone to check that all elements are functioning correctly. Remove all packaging and combustible items from the oven. Turn on the oven selector switch and thermostat knob to check that the oven is functional on all modes.

### Support legs

4 support legs are supplied separately and are fitted on location to the four corners of the lower support frame (Fig.11)

After unpacking the cooker, lift it approx 250mm to fit the legs then gently lower the cooker to keep undue strain from the legs. It is recommended to use a lifting device instead of tilting the unit.

Transit supports are left in situ. Each leg is firmly pushed over one of the transit supports. If the legs are not used and the cooker is mounted onto a plinth, leave transit legs in position to allow for clearance.

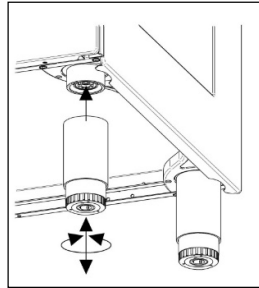

Fig 11

### Up-stand Installation

The up-stand is packaged at the bottom rear of the cooker. The up-stand is fixed along the rear of the cooker hob. Screw fixing points for locating the up-stand are at either end.

1. Place the up-stand on the rear of the hob, line up locating holes and secure with the screws supplied.

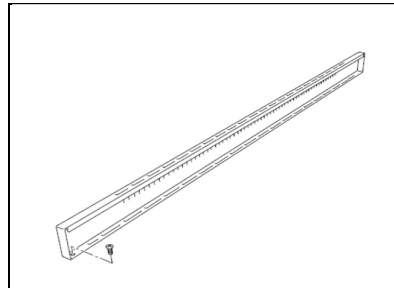

Fig 12

### Anti-tilt restraint

Once legs are adjusted to the correct height, fit the anti-tilt restraint brackets. The anti-tilt brackets must be fixed to the rear wall as shown below.

1. To calculate the position of brackets up from the floor, measure to the bottom of the anti-tilt bracket location slots on the back of the cooker and add 32mm.
2. Secure the brackets in position on the rear wall with suitable fixings. (Note that brackets are fixed 60mm in from the side edges of the cooker).
3. Lift the cooker into place until it sits 130mm away from the wall then gently manoeuvre the cooker further back until the brackets are fully inserted into the rear side of the cooker. Care should be taken to not cause damage to the flooring or to put unnecessary strain on the legs flooring.

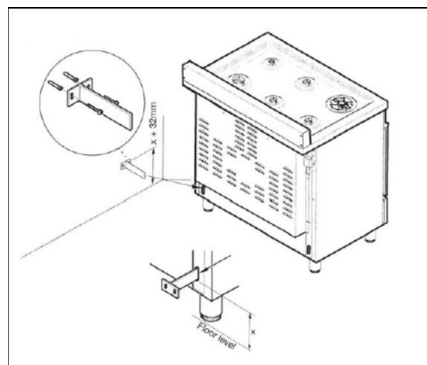

Fig 13

### Cast iron griddle

A griddle is available as an optional accessory.

#### **To use a griddle:**

**1** Place the griddle on top of the pan support.

**2** Pre-heat the griddle on full power for 4-5 minutes before adding the food. Most foods (eggs in particular) will require a small amount of oil to help prevent sticking. Turn the food half-way through the cooking time to sear both sides. The more the griddle is used, the better the cast iron will absorb oils, giving it a natural non-stick finish.

## INDUCTION

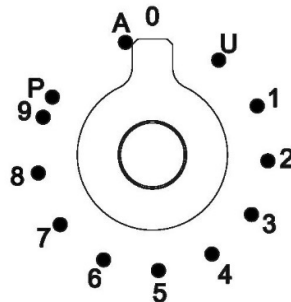

#### **Functions**

**U**: Keep Warm 70°C

**1...9** : Power Level

**P** : Booster

**A** : Heating Accelerator

### Hob control knob

These knobs provide control of the ceramic hob's cooking zones.

The zone it controls is shown above each knob. Turn the knob to the right to set the zone's operating power; the settings range from a minimum of 1 to a maximum of 9. The working power is shown by a display on the hob.

### Heating accelerator

Each cooking zone is equipped with a heating accelerator.

This system allows the zone to be operated at peak power for a time proportional to the heating power selected.

To start the heating accelerator, turn the knob to the left, select setting "A" and then release. The letter "A" will appear on the display on the hob.

You now have 3 seconds to select the heating setting of your choice. Once a setting between 1 and 9 has been selected, "A" and the chosen setting will flash in alternation on the display. '

While the heating accelerator is in operation, the heating level can be increased at any time. The "full power" time will be modified accordingly. If the power is reduced by turning the knob anticlockwise, option "A" is automatically deactivated.

### Power Function

The power function allows the user to operate each heating zone continuously at the maximum power for a time of no more than 10 minutes. This function can be used, for example, to bring a large amount of water to the boil in a hurry, or to turn up the heat under meat.

Turn the knob clockwise and set heating level 9, then use the knob to set the "P" position and release it. "P" appears on the corresponding zone display.

After 10 minutes, the power is reduced automatically, the knob returns to the 9 setting and the "P" disappears.



However, the power function can be turned off at any time by reducing the heating level.

When the power function is selected for one heating zone (e.g. the left front zone), the power absorbed by the second zone (left rear zone) might be reduced to supply the maximum available energy to the first zone.

Consequently, the power function takes priority over the heating accelerator.

If a pan is removed from the cooking zone while the power function is on, the function is switched off.

**Bridge Function** 2 cooking zones bridged behave like one cooking zone and can also be controlled like only one. For this range, the bridge can only be activated vertically on the octa inductors. To activate it, turn both concerned knobs to the right until the stop during 2 s. On the rear display you will have the bridge indication and on the front display you choose your power level.

#### Time limitation system

Power level	Operating time limitation in Min.
1	520
2	402
3	318
4	260
5	212
6	170
7	139
8	113
9	90

#### Limitation power:

1. Make sure that all knobs are on position '0'
2. Turn the knob front left and front right simultaneously to leftoverwind position and hold for 3 s. then release both knobs.  
 . the two upper displays now show the power per phase.  
 . the two lower display show the number of phase(e.g. "2 P" for 2-phase connection)
3. Turn the knob front right X1 to left overwind position to toggle through the offered settings.
4. Perform no action for 10 s. => the setting which is displayed will be saved permanently. The cooktop goes to OFF mode and can be operated regularly.

Configuration of power management	Power supply per phase [A]	Number of phases	Voltage [V]	Power limit per phase
1	29,13 A	1	230 V	6700 W
2	13,00 A	2	230 V	3000 W
3	26,00 A	1	230 V	6000 W
4	23,91 A	1	230 V	5500 W
5	10,43 A	2	230 V	2400 W
6	18,26 A	1	230 V	4200 W
7	16,00 A	1	230 V	3700 W
8	10,43 A	1	230 V	2400 W
9	5,22 A	1	230 V	1200 W

## Child lock

For activate or deactivate the child lock, it is the same process for both:  
Turn the two left knobs simultaneously to the left overwind ( position "A") and hold them for at least 3 sec.

## HOB

### ATTENTION:

Metal items such as cutlery or lids must never be placed on the surface of the hob since they may become hot.

### Cooking zones

The appliance is equipped with 4/5 cooking zones having different diameters and powers. Their positions are clearly marked by rings, while the heating power is only released in the area shown on the ceramic hob. The 4/5 cooking zones are of HIGH-LIGHT type and start to heat up a few seconds after they are switched on. The heat level of each zone can be regulated from the minimum to the maximum setting using the knobs on the front panel.

Underneath each cooking zone there is a coil called an inductor, supplied with power by an electronic system, which generates a variable magnetic field. When a pan is placed inside this magnetic field, the highfrequency currents concentrate directly on the bottom of the pan and produce the heat needed to cook the foods.

The 4/5 lights between the cooking zones come on when the temperature of one or more cooking zones exceeds 60° C.. The lights go out when the temperature drops to below about 60° C.

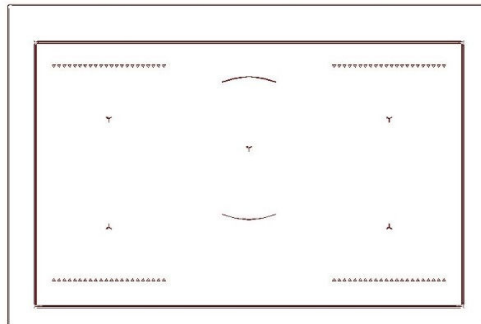

Zone number:	Power absorption	
	Normal operation:	With power function:
Front left	1600 W	1850 W
Rear left	2100 W	3000 W
Central	2300 W	3000 W
Rear right	2100 W	3000 W
Front right	1600 W	1850 W

When the hob is used for the first time, it should be heated to its maximum temperature for long enough to burn off any oily residues left by the manufacturing process, which might contaminate foods with unpleasant smells.

### Types of pans

This type of appliance can only operate with pans of special kinds.

The bottom of the pan must be iron or steel/iron to generate the magnetic field necessary for the heating process.

Vessels made from the following materials are not suitable:

glass;

porcelain;

pottery;

steel, aluminium or copper without magnetic bottom;

To check that a pan is suitable, simply place a magnet close to its bottom:

if the magnet is attracted, the pan is suitable for induction cooking. If no magnet is to

hand, put a little water in the pan, place it on a cooking zone and switch it on. If the symbol appears on the display instead of the power, the pan is not suitable.

The pans used for cooking must have certain minimum diameters to ensure satisfactory operation.

Pans larger than the cooking zones can also be used, but it is important to ensure that the bottom of the pan does not touch other cooking zones, and that it is always centred over the perimeter of the cooking zone

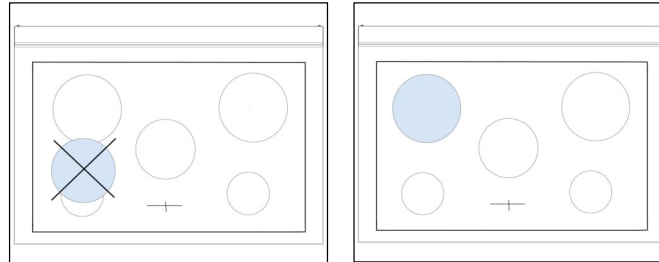

Use only vessels specially designed for induction cooking, with thick, completely flat bottom; if these are not available, the pans used must not have crowned (concave or convex) bottom

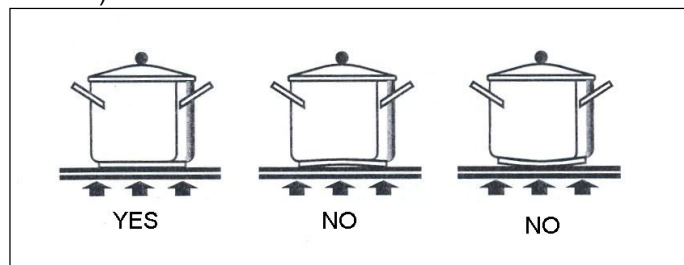

Pan present device

Each cooking zone is equipped with a "pan present" device, which ensures that cooking cannot start unless a suitable pan is present on the cooking zone and properly positioned.

If the user attempts to switch on the cooking zone with the pan not positioned properly or with a pan which is not of suitable material, a few seconds after the zone is switched on the U symbol will appear to warn the user that an error has been made.

Residual heat

Each cooking zone is equipped with a device which warns of residual heat. After any cooking zone is switched off, a flashing 'H' may appear on the display. This warns that the cooking zone concerned is still very hot.

Locking-out the hob

When not in use, the hob can be "locked out" to prevent children from accidentally switching it on.

With the cooking zones off, turn the knobs of zones 1 and 2 to the left simultaneously until "L" appear on the power display and then release the knobs.

To deactivate it, repeat the same procedure: the cooking zone displays will stop displaying the "L", indicating that the cooking zone lock-out function has been deactivated.

**Attention:**

Take care not to spill sugar or sweet mixtures onto the hob during cooking, or to place materials or substances which might melt (plastic or aluminium foil) on it; if this should occur, to avoid damage to the surface, turn the heating off immediately and clean with the scraper while the cooking zone is still warm. If the ceramic hob is not cleaned immediately, residues may form which cannot be removed once the hob has cooled.

**Important!**

Keep a close eye on children because they are unlikely to see the residual heat

warming lights. The cooking zones are still very hot for some time after use, even if they are switched off. Make sure that children never touch them.

**WARNING:** Under no circumstance use aluminium foil or plastic containers to hold the food while cooking on a glass-ceramic hob.

**WARNING:** Do not touch the cooking area as long as the light indicating residual heat on the glass-ceramic hob, is "on"; this indicates that the temperature in the relative area is still high.

**WARNING:** Never place pan with bottoms which are not perfectly flat and smooth on the hob

**WARNING:** If you notice a crack in the ceramic hob, disconnect the appliance from the electricity supply and contact a service centre

**WARNING:** Your glass-ceramic hob is thermal shock resistant and resistant to both heat and cold.

If you drop a heavy pot on your hob it will not break.

On the contrary, if a hard object, such as the salt shaker or the spice bottle strikes the edge or the corner of the hob, the hob may break.

**WARNING:** never use the glass-ceramic hob as support surface.

## **SEPARATE GRILL COMPARTMENT (triple oven cavity models only)**

The powerful 2.4kW grill can be used for short periods of time (e.g. toast/muffins) with the door open, however for better efficiency it is recommended that the door is closed. A cooling fan situated behind the control panel switches on to keep the control knobs at a comfortable temperature when the grill is in use.

The grill pan assembly The grill compartment is fitted with telescopic runners to make it easier to access your food. To fix the grill pan onto the runners, simply extend both runners, then lower the grill pan into place, ensuring the back corners of the grill pan rest against the vertical pins. The wire trivet that fits into the grill pan is reversible to provide two grilling heights.

### **To use the grill:**

**1** Use the reversible trivet to select the correct height for the food you wish to grill. Using the trivet at the lowest height will help to slow down the cooking process.

**2** Turn the grill control knob (Fig.20A-20B) clockwise to the maximum setting 7. The adjacent red thermostat light will illuminate. For best results you should preheat the grill for 3-5 minutes.

**3** Once preheated, adjust the grill control knob clockwise to the desired setting 1 to 7.

**4** To turn off the grill, turn the control knob anti-clockwise to the "O" position.

At the end of cooking remove the grill pan for cleaning. If high fat content foods have been prepared with the door closed, leave the grill turned on at maximum temperature for 5 minutes. This will burn off any fatty residue on the elements.

Always use oven gloves when handling the grill pan and turning food. Do not line the grill pan with aluminium foil, this can cause damage to the enamel coating and the grill elements.

It is recommended to use fan assisted grilling at 200°C with the door closed in the main oven for foods that need grilling for longer than 10 minutes (e.g. meat, fish). See page 24 for more info.

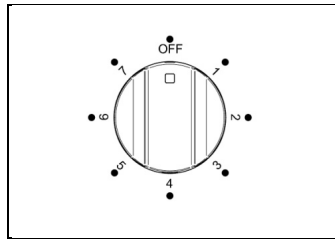

Fig 20A

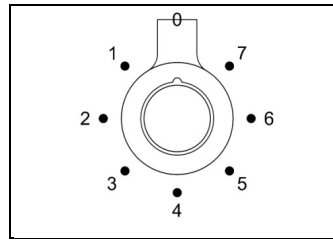

Fig 20B

Most foods such as bread products and bacon are grilled on the higher settings. For thicker cuts of meat, chicken pieces etc. you should use fan assisted grilling in the main oven.

**Suggested cooking times**

(turn the food halfway through the cooking time):

Food	Grill setting	Cooking time
Bacon	High 7	4 – 6 minutes
Toasted bread or muffins	High 7	4 – 6 minutes
Crème brûlée	High 7	3 – 5 minutes
Crumpets	High 7	4 – 6 minutes

## OVENS

### Using the electric thermostat

The maximum oven temperature can vary according to the tolerances of the different materials and installation conditions between 220-250°C.

The thermostat supplied with the relative models maintains a constant temperature inside the oven at a specific temperature setting ranging from 50°C to 250°C (Fig. 25A-25B and Fig.25C for pro t version only ) or 50°C to T max°C for hybrid version only (Fig.25D-25E). Turn the knob clockwise and align the selected temperature indicated on the ring with the index etched on the control panel. Thermostat operation is indicated by an orange light which will turn off when the temperature inside the oven is 10°C greater than the temperature setting, and will turn on when the oven is 10°C less than the temperature setting. The thermostat can control the oven elements only if the relative switch is in one of the possible oven element operating modes: if the switch is in position 0, the thermostat has not effect on the oven elements, which remain off.

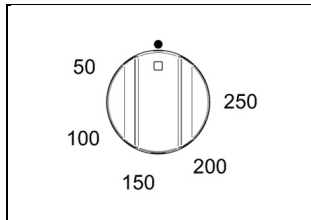

Fig 25A

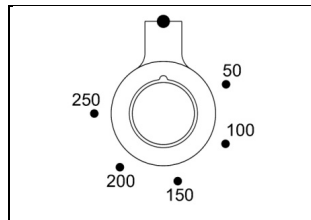

Fig 25B

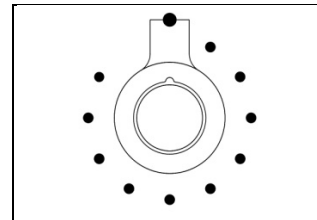

Fig 25C

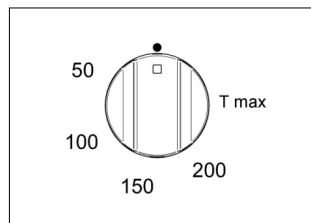

Fig.25D

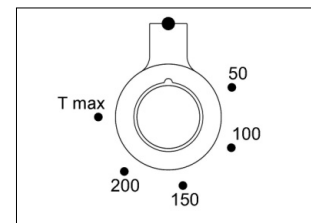

Fig.25E

### Using the electric oven **Before using the ovens for the first time:**

- Remove all packaging and accessories from inside the ovens.
- Heat the ovens to 200°C for ½ hour to burn off manufacturing residues.
- The automatic programmer must be set to Manual mode for ordinary cooking.
- The oven will not function when set in Automatic mode. See page 28.

#### **To use the ovens:**

**1** Turn the function selector knob (Fig.27A-27B and Fig.28A-28B) clockwise to the desired function.

The orange light will illuminate, indicating that the element is on.

**2** Turn the temperature selector knob (Fig.29A-29B and Fig.30 for PRO T version Only or Fig.29C -29D for hybrid version only) clockwise to the desired temperature.

The orange light will go out once the

oven has reached temperature and is ready for use. It is normal for this light to go on and off during cooking as the elements maintain the temperature (The operation of the oven is indicated by the display of the programmer for PRO T version only).

**3** To turn the oven off, turn the function selector and temperature knobs anti-clockwise back to •.

Steam may be generated when cooking. As a precaution, always open the door in two stages. First, partially open the door by 100mm for a few seconds to allow the steam to escape, then open the door fully. Keep your face and head away from the door when opening.

Never line the oven interior with foil as this can cause overheating and damage the enamel. Never cook on the oven base. Always place dishes and trays onto an oven shelf. Do not leave the grill pan or other dishes on the oven base as damage to the oven may occur.

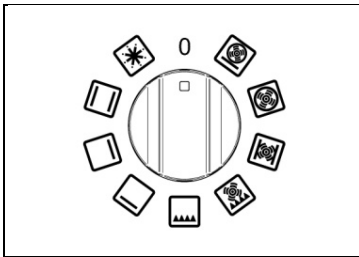

Fig 27A

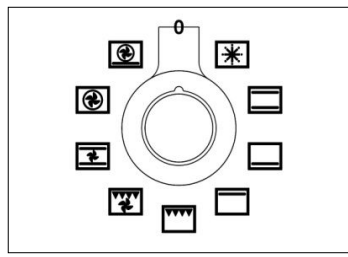

Fig 27B

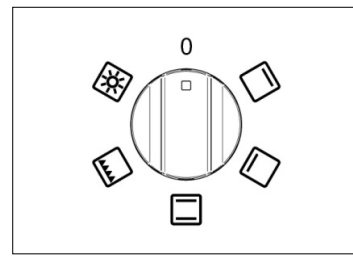

Fig 28A

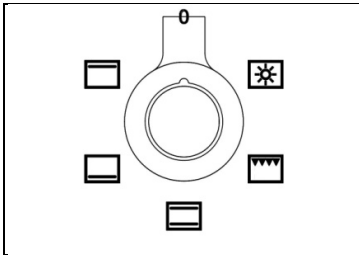

Fig 28B

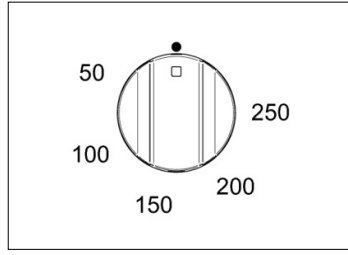

Fig 29A

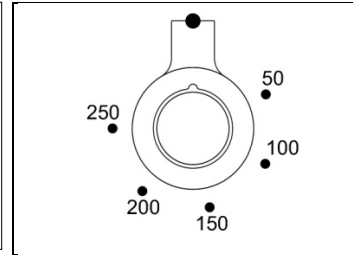

Fig 29B

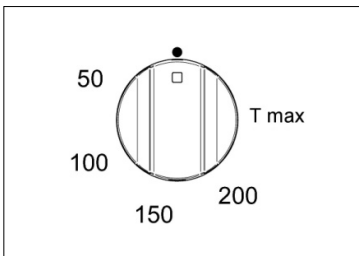

Fig 29C

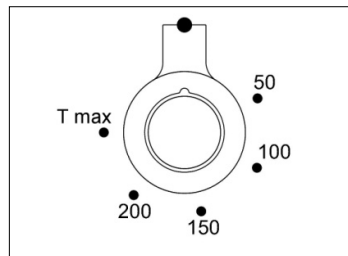

Fig 29D

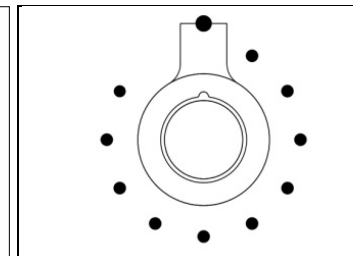



Fig 30

### Preheating the oven:

'Fast preheat' provides the most efficient and fastest way to preheat the main oven (left hand oven). It will also ensure your oven cooks evenly. Use 'Fast preheat' as follows (  ):

- 1 Select 'Fast preheat' (using the oven function selector) and the required cooking temperature (using the temperature selector). Allow the orange thermostat light to come on and off several times. This allows the temperature to stabilize before introducing food (The operation of the oven is indicated by the display of the programmer for PRO T version only).
- 2 Select the preferred cooking function and place the food in the oven.
- 3 When preparing heat sensitive foods such as cakes or meringues using the 'True Fan' function, allow the orange light to come on and off again several times to allow the top element to cool slightly.

'Fast preheat' is unsuitable for use as a cooking function. It is a quick pre-heat system.

### Oven functions

When using any of the functions in the multifunction oven (except grilling and defrosting) it is always recommended that you pre-heat the oven using the 'Fast preheat' function, before switching over to your desired cooking function.

When using the Fan Assisted or True Fan oven function, it is advisable to reduce the oven temperature by 20°C if following a recipe written for a conventional oven. Check the food often through the latter stages of cooking until you are used to the cooking times and temperatures.









The ovens have a range of cooking functions providing different heat zones. The 'True Fan' function for instance, is most suitable for cakes, desserts and batch baking. The 'Fan Assisted' function gives more browning so is more suitable for roasting meats and vegetables or frozen potato products.

### Example: To cook a turkey:

When cooking a turkey, the grill pan can be used as a roasting tin. Line the pan with a double layer of extra wide foil, allowing enough foil to wrap the turkey loosely. It is important to allow enough space around the sides and top of the oven for the hot air to circulate. Make sure that the foil is not touching the sides or top of the oven. In a 60cm oven a turkey of 9 to 11 kg can be cooked. In a 40cm oven a turkey of 6 – 9 kg can be cooked.

The oven light operates on selection of any oven function

The oven and grill functions are both contained within the one oven compartment and can be used in conventional mode or with the fan for fan assisted mode. The functions are as follow :

Symbol	Function	Ovens found in	Elements used	What to use it for
	Fast preheat	60cm and 90cm	Top plus fan	It is recommended that the oven is always pre-heated before use, whatever the cooking temperature. Fast preheat is not suitable for cooking - once the oven has reached temperature, switch to one of the oven functions below.
	Defrost	60cm and 90cm	None	Place small frozen items on an oven tray at the lowest shelf position, and set the temperature selector knob to 0°C. Never use heat to defrost as this can pose a health risk. Larger items such as joints, or a whole chicken or turkey, should be defrosted in the refrigerator.
	Conventional oven	All ovens	Top and bottom	Ideal for roasting and for baking items such as bread or rich fruit cakes on a single shelf.
	Lower element	All ovens	bottom	Use at low temperatures for slow-cooking casseroles, custard or for warming plates. Use at high temperatures for cooking sweet and savoury pastry tarts.
	Upper element	All ovens	Top	Use for browning and reheating dishes such as lasagne, moussaka and cauliflower cheese.
	Conventional grill	All ovens	Grill	Ideal for crumpets, muffins and Welsh rarebit. Use when grilling for less than 15mins. For foods needing a longer time use fan assisted grilling.
	Rotisserie	30cm and 40cm	Grill	The rotisserie motor rotates food under the grill for succulent results. Suitable for poultry, game birds and rolled and tied joints of pork or lamb.
	Fan assisted grill	60cm and 90cm	Grill plus fan	The fan circulates hot air around the food helping to cook it all the way through. Ideal for cooking meat such as sausages and chicken portions. Cooking high water content foods such as bacon and chops with this function helps to reduce condensation. (Recommended: Door closed 175°C, 2nd from top shelf, turn the food over halfway through.
	Fan assisted oven	60cm and 90cm	Top and bottom plus fan	The fan circulates the hot air around the oven for uniform cooking of larger quantities of food. Use for roasting vegetables, meat and poultry, or baked fish. This function is the best one for cooking frozen potato products and breaded/battered chicken or fish.
	True fan oven	60cm and 90cm	Circular fan element only	This function is suitable for most recipes and is an efficient way to cook. The temperature is kept uniform throughout the oven and is particularly suitable for baking on several shelves or for batch cooking.
	Pizza	60cm and 90cm	Bottom plus others	Use for cooking pizza, pastry or flat breads to get a perfectly cooked base.

### Using the grill

The grill pan consists of a wire trivet and enamel tray. Place food on the wire trivet. A lower shelf position can be used to slow cooking down, or the temperature can be reduced. A detachable grill pan handle is supplied for removing the hot tray.



Both the Fan Assisted Grill and Conventional Grill functions are designed to be used with the oven door closed. This ensures efficient preheating and even cooking. Use conventional grill at 150°C max setting and or fan forced grill at 175°C max setting.

When grilling, always pre-heat the grill element for 5 minutes before introducing food. It is recommended that the grill pan is always removed from the oven when not in use, as air flow around the oven can be impaired. The grill should be used with the oven door closed. Use the Fan Assisted Grill function for thicker pieces of meat and when cooking high water content foods to reduce condensation.

Always use oven gloves when handling the grill pan and turning food. Do not line the grill pan with aluminium foil, this can cause damage to the enamel coating and the grill elements.

At the end of cooking remove the grill pan for cleaning. If high fat content foods have been prepared, leave the grill turned on at a maximum temperature for 5 minutes to clean the grill element.

### Grill Pan

The grill pan should be removed from the oven when not required. If left in the oven it will block the flow of hot air. This can cause hot spots and could damage the grill pan and the oven interior. When using in 60cm and 90cm ovens the grill pan can be used in the top two shelf positions for grilling, or in the bottom two shelf positions for roasting. When using the grill pan for roasting, the 'True Fan' function should be used.

When using in 30cm or 40cm ovens the grill pan should only be used in conjunction with the grill (in the top two shelf positions) or for the rotisserie (in the bottom shelf position).

### **Fan assisted grilling**

<b>Food</b>	<b>Grill setting</b>	<b>Cooking time</b>
Chicken places	175°C	30 minutes
Burgers	175°C	18 minutes
Fish fillets	175°C	10-15 minutes
Lamb chops	175°C	15 minutes
Gammon steaks	175°C	15 minutes
Chicken breasta	175°C	30 minutes
Pork chops	175°C	25 minutes

These times are purely advisory and will depend on the size and cut of the food. Please ensure foods are cooked through before serving (pork, fish and chicken in particular).

### Using the grill or fan grill functions

For even grilling it is important to preheat the grill before introducing the food. This will ensure good sealing and even browning of the food. It is recommended that the door remain closed for safety and efficiency when using this function. The separate grill compartment can be used with the door open if preferred, for short grilling periods (e.g. up to 15 minutes).

Aluminium foil should not be used to line the oven cavity or grill pan. This can cause overheating, buckling and cracking of the enamel surfaces.

### Using the rotisserie (secondary oven TOP model)

Warning: The maximum weight for the rotisserie is 3.5 kg.

- 1** Place the grill pan in the bottom shelf position to catch any drips.
- 2** Place the wire support shelf into the oven so that it sits level with the hole at the back of the oven.
- 3** Pre-heat the oven. A temperature of 220° C is recommended.
- 4** Place one of the forks onto the spit and tighten the thumbscrew.
- 5** Skewer the meat with the spit, ensuring that the fork firmly pierces and holds the meat. When cooking poultry, aim for the bone area under the breast.
- 6** Fit the second fork, again ensuring that the meat is firmly pierced. For poultry, the fork should enter just below the thighs. Tighten the thumbscrew into place. Ensure that the food is well balanced to avoid stress on the motor drive. The maximum weight bearing of the spit is 3.5kg.
- 7** Turn off the oven. Fit the handle to the spit assembly, then place the spit over the wire support shelf and place the spit end into the hole in the rear oven wall. Locate

the spit support onto the wire shelf. Remove the handle (the handle is used solely for moving the spit) and close the oven door.

8 Turn the oven back on to the rotisserie/grill function (  ).

As a guide, most meats will require about 15 minutes per 450g at 220°C. Always check that food is thoroughly cooked and that the juices of poultry run clear when pierced.

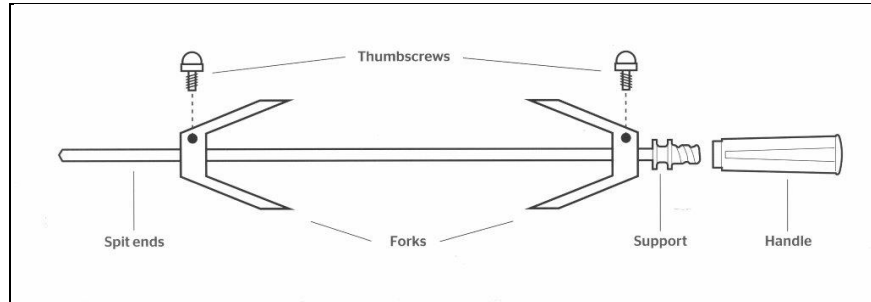

Operating the oven light in the 60cm and 90cm ovens

Turn the function selector control knob to switch the light on. The light will remain on while the oven is in use. In the 30cm and 40cm ovens, turn the function control to the light icon. The light will also operate once a function has been selected for cooking.

Cooling fan











The range cooker is fitted with a thermostatically controlled cooling fan designed to prevent the control panel and knobs from overheating. The fan will operate when a certain temperature is reached. It will turn off when the temperature decreases.

**USING THE AUTOMATIC PROGRAMMER (PRO T model only)**

The programmer with touch controls allows to program the cooking cycle with the following cooking tools:

- Delay;
- Cooking time;
- Probe
- Clock or Time

Icons legend

	Remove selection or leave menu
	Confirm selection
 	Scroll left/right and up/down (keep press the button to increase the speed)
	Settings menu
	System Settings
	Timer
	Delay
	Cooking time
	Food probe
	Level indicator of temperature

Home screen

- To active timer/set up menu touch control zones.
- In this screen the temperature knob is not active.
- To switch directly to the functions cooking selection screen turn the function knob and the icon of the selected function will appear on the display.

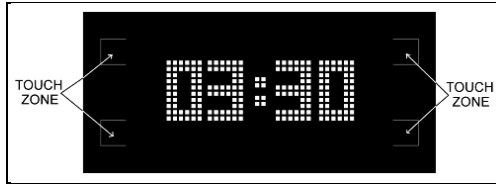

Timer/set up menù

To advance to the system settings select the set-up icon.  
In this screen it is possible to set the time (12 or 24h), the type of degrees (metric °C or imperial °F) and the intensity of the buzzer.

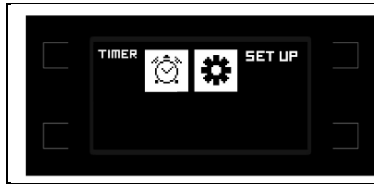

**Set up**

Select field with and confirm

Set the desired values and confirm

Leave menù .



**Timer**

This function is simply a minute minder: the timer can be used independently from cooking and it will not turn off the oven at the end of the set time. To shut off automatically the oven, select COOKING TIME (see below).

Set the desired values and confirm

Leave menù .



Functions cooking selection

The display will show the desired function icon turning the function knob  
In this setting the touch controls are not active.

N.B. the function knob has the priority and the display will always show the choice of the function.

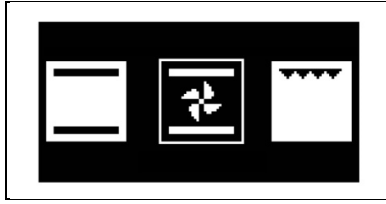

Choose the desired temperature turning thermostat knob to move to the cooking tools menu. Wait to 3/4 seconds confirm the selected value and the display will show the status screen.



Status screen

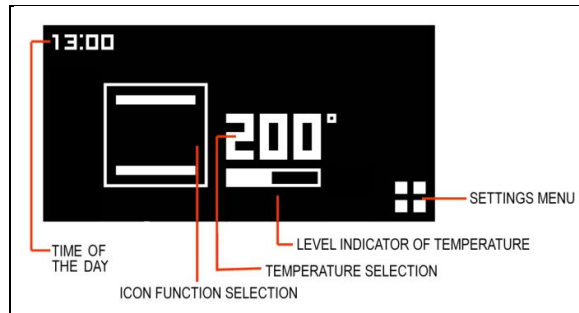

Cooking tools menu

If not selected any cooking instrument after inactivity of 3/5 seconds the screen returns to the initial state or to status screen in case the oven is in operation.

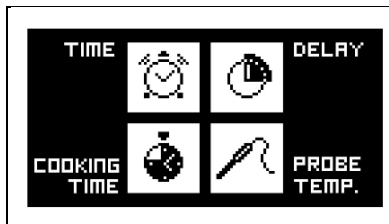

**Time**

Press the touch zone next to  (settings menu) to enter the cooking tools menu screen and select time touching the corresponding touch control zone.

Set the desired values   and confirm 



Leave menu .



**Delay**

Press the touch zone next to  (settings menu) to enter the cooking tools menu

screen and select delay touching the corresponding touch control zone.

Set desired time before oven will turn on   and confirm 

The oven will turn on at the set time and it will be confirmed with a repeating tone.  
Touch any touch control area to stop tone.

Leave menu .



After 3/5 seconds of inactivity the screen returns to the status screen.



### Cooking time

Press the touch zone next to  (settings menu) to enter the cooking tools menu screen and select cooking time touching the corresponding touch control zone.

Set the desired duration   and confirm 

The display will show the countdown.

The oven will turn off at the end of the countdown and it will be confirmed with a repeating tone. Touch any touch control area to stop tone.

Leave menu .



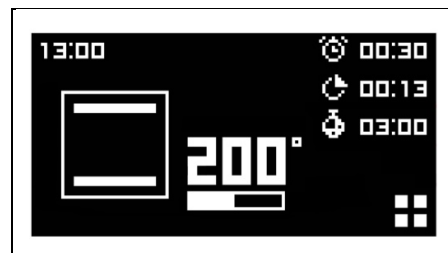

After 3/5 seconds of inactivity the screen returns to the status screen.



### Probe (PRO T model only)

Press the touch zone next to  (settings menu) to enter the cooking tools menu screen and select probe touching the corresponding touch control zone.

Set the desired food temperature with   and confirm .

The display will show the set temperature and the actual temperature measured by the probe. The oven will turn off when the desired food temperature is reached. End of cooking will be confirmed with a tone. To stop tone touch any touch control area.

Leave menu .

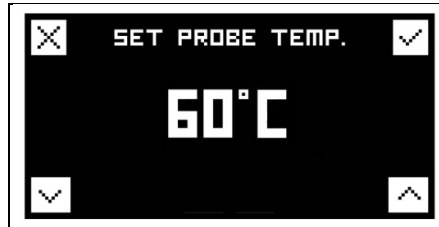

After 3/5 seconds of inactivity the screen returns to the status screen.



The probe works by measuring the temperature inside a joint of meat. There are no set cooking times as the cooking time depends on how long it takes for the internal temperature of the meat to reach the set care temperature. This can vary depending on the weight and type of meat. For this reason it is not recommended that the probe is used with the automatic timer.

The meat is ready when the temperature set on the right hand side of the clock fascia is reached and the oven then switches off.

Foods suitable for use with the probe are large joints of boneless meat or joints that have been deboned & stuffed eg. topside of beef, pork fillet, deboned leg of lamb/pork.

**It is important that:**

- Meat should be as close to room temperature as possible.
- The probe is inserted into the centre of the joint of meat to give accurate results. Once in the centre of the meat it is cooked to the temperature selected on the clock fascia panel.

If the probe is not fully inserted to the centre of the meat, the desired cooking temperature may not be reached.

**To use:**

- 1** Remove the probe part cover on the left hand side of the oven and insert the short metal end of the probe.
- 2** Then place the meat in the roasting tin on the 2nd shelf from the base of the oven and insert the long end of the probe into the thickest part of the meat towards the centre. Make sure the rubber probe cable is not trapped in the door, or touching the oven shelf as this could affect the results. Any slack in the cable should rest in the roasting tin.
- 3** When both temperatures on the display reach the temperature set, the oven will switch off.

Below there is a chart to be used as a guideline. Meat cooked this way must not exceed 2.5kg in weight and should be left at room temperature for a couple of hours before cooking.

The probe is best used for red meats and pork, as suggested by the guideline

temperatures below. It is not recommended to cook poultry using the probe.

Cut of meat	Preferred result	Suggested core temp
Topside of beef	Medium rare	63°C
Topside of beef	Medium	70°C
Deboned leg of lamb	Medium pink	69°C
Deboned leg of pork	Cooked through not pink	85°C minimum temp

- The meat does not need to rest before carving as it is cooked at a lower temperature than roasting.

#### Important

DO NOT LEAVE THE PROBE IN THE OVEN CAVITY WHEN NOT IN USE.

#### Reset

To reset the cooking tools (delay / cooking time and probe) bring both knobs on the zero position "0".

## OVEN TEMPERATURE GUIDE

### Selecting the correct cooking temperature

The centre of each number should be in line with the central dot icon on the fascia. When using the 'True Fan' or the 'Pizza' function, select a temperature 20°C lower than your recipe states. Most recipes are written for the conventional, but, more recently, magazines, food packaging and cook books have started to add the required Fan temperature, usually in brackets. There are 4 shelf positions – 1 is the lowest and 4 is the highest near to the grill.

If cooking one dish use shelf position 2, if cooking more than one tray depending on the height of the tray or food it is suggested to cook on shelf positions 1 & 3.

NATURAL CONVENTIONAL ELECTRIC OVEN COOKING TABLE 			
	TEMP °C	HEIGHT	MINUTES
<b>MEAT</b>			
PORK ROAST	225	3/4	60-80
BEEF ROAST (YOUNG STEER)	225	3/4	60-80
BEEF ROAST	250	3/4	50-60
VEAL ROAST	225	3/4	60-80
LAMB ROAST	225	3	40-50
ROAST BEEF	230	3/4	50-60
ROAST HARE	250	3/4	40-50
ROAST RABBIT	250	3	60-80
ROAST TURKEY	250	3	50-60
ROAST GOOSE	225	3	60-70
ROAST DUCK	250	3/4	45-60
ROAST CHICKEN	250	3/4	40-45
<b>FISH</b>			
	200-225	2	15-25
<b>PASTRY</b>			
FRUIT PIE	225	2	35-40
TEA CAKE	175-200	2	50-55
BRIOCHEs	175-200	2	25-30
SPONGE CAKE	220-250	2	20-30
RING CAKE	180-200	2	30-40
SWEET PUFF PASTRIES	200-220	2	15-20
RAISIN LOAF	250	2	25-35
STRUDEL	180	2	20-30
SAVOIA COOKIES	180-200	2	40-50
APPLE FRITTERS	200-220	2	15-20
SAZOIARDI SANDWICH	200-220	2	20-30
TOAST SANDWICH	250	3	5
BREAD	220	3	30
PIZZA	220	2	20

VENTILATED ELECTRIC OVEN COOKING TABLE 			
	TEMP °C	HEIGHT	MINUTES
<b>MEAT</b>			
PORK ROAST	160-170	2	70-100
BEEF ROAST (YOUNG STEER)	170-180	2	65-90
BEEF ROAST	170-190	2	40-60
VEAL ROAST	160-180	2	65-90
LAMB ROAST	140-160	2	100-130
ROAST BEEF	180-190	2	40-45
ROAST HARE	170-180	2	30-50
ROAST RABBIT	160-170	3	80-100
ROAST TURKEY	160-170	3	160-240
ROAST GOOSE	160-180	3	120-160
ROAST DUCK	170-180	2	100-160
ROAST CHICKEN	180	2	70-90
<b>FISH</b>			
	160-180	2-3	
<b>PASTRY</b>			
FRUIT PIE	180-200	2	40-50
TEA CAKE	200-220	2	40-45
BRIOCHES	170-180	2	40-60
SPONGE CAKE	200-230	2	25-35
RING CAKE	160-180	2	35-45
SWEET PUFF PASTRIES	180-200	2	20-30
RAISIN LOAF	230-250	2	30-40
STRUDEL	160	2	25-35
SAVOIA COOKIES	150-180	2	50-60
APPLE FRITTERS	180-200	2	18-25
SAZOIARDI SANDWICH	170-180	2	30-40
TOAST SANDWICH	230-250	3	7
BREAD	200-220	3	40
PIZZA	200-220	2	20

When cooking a Dundee cake or rich fruit cake, always wrap 2 layers of brown paper around the sides and check after each hour.

A piece of brown paper may need to be put over the top. Always ensure foods are cooked through before serving, pork, poultry and fish in particular. \* See page 22 for more information on cooking a turkey.

### USING THE THERMOMETER (Fig.31)

The cooker is fitted with a device to measure the temperature in the middle of the oven.

This lets you check the temperature inside the oven and adjust food cooking temperatures more accurately.

#### Electric oven

When you turn on the oven, the orange light comes on to indicate that the heating elements are working: The thermometer dial will start to move towards the set temperature.

The orange light will keep going on and off, indicating that the heating elements are working to maintain the temperature inside the oven.

The light may go off for a few minutes before the thermometer has reached the temperature required. This is normal, because operation of the heating elements is regulated so that heat is distributed properly inside the oven.

Heat is optimally distributed inside the oven when the thermometer dial has stopped.

If the oven temperature drops or goes up, the thermometer dial will follow these variations in the same way.

When the oven is turned off, the temperature on the thermometer will slowly drop until it reaches room temperature.

NOTE: The exact temperature is read on the thermostat knob. The thermometer gauge is for reference only.



Fig 31



## CLEANING YOUR COOKER

A false reading of the temperature may be caused by heavy food soiling, residual oven cleaner on the thermostat and/or the roof elements, or a dislodged thermostat phial. Cleaning should be carried out regularly and with care. Always disconnect the electricity supply to the appliance before any cleaning takes place. Never allow fat or oil to build up on any surface, particularly on oven bases and oven trays, as this can lead to permanent staining or the risk of fat fires.

### Griddle

- As the Griddle is heavy we recommend that you clean it on the hob without moving it.
- After cooking, allow the Griddle to cool until just warm.
- Use a spatula to remove any cooking residue.
- Wipe away any fat in the drip tray with kitchen towel.
- Clean the whole surface with warm water and washing-up liquid, using a stainless steel scourer. Always work with the grain of the stainless steel.
- Some foods with a high salt content (such as bacon) may leave white marks. For these and other stubborn marks use a cream cleaner suitable for stainless steel surfaces.

### Cast iron griddle

- The cast iron griddle will absorb oils as it is used. Over time it will develop a natural non-stick finish.
- After cooking, scour the griddle whilst still warm with warm water, and dry immediately.
- Rub a little olive oil into the cooking surface to protect the cast iron while not in use.
- Avoid using detergents as this will remove the natural non-stick coating. Do not clean in a dishwasher.

### Cleaning your induction hob

Allow the hotplate to cool down until the residual heat indicator is extinguished before commencing any cleaning. Never use scouring powders or paste, metal scourers, oven cleaners or any abrasive cleaning products on the hotplate. It is important that any spillage is cleaned from the hotplate before it is used again.

- For light soiling, wipe with a soft cloth, warm water and washing-up liquid. For a streak free finish, polish dry with an microfibre cloth.
- For more stubborn marks and to condition the surface, use a good quality hob cleaner/conditioner, following the manufacturer's instructions.
- For spillages with a high sugar content (such as jam) or the accidental melting of plastic or alloy materials, turn off the hotplate and remove the spillage immediately. Take care as the hotplate and the spillage will be very hot.

### Fascia, controls and external surfaces

Do not use strong or abrasive cleaning agents or materials on the controls, fascia panel or coloured cooker surfaces. This can cause damage to the calibrations and icons and permanently scratch the surfaces.

### Coloured surfaces:

Clean with a soft cloth, warm water and washing-up liquid. Whilst still damp, polish dry with an microfibre cloth.

### Stainless steel:

For stubborn marks use a reputable non-abrasive stainless steel cleaner. Always work with the grain of the stainless steel, rinse well and polish dry with an microfibre cloth.

### Glass:

Clean with a soft cloth, warm water and washing-up liquid. Difficult marks on the glass can be removed using a cream cleaner. Never use sharp implements to remove marks as this could scratch the glass.

### Ovens:

Always allow the oven interior to cool before cleaning.

#### Interior oven door enamel and glass

Never use sharp implements to remove stains as this could scratch the surface. The door enamel and glass surfaces can be cleaned with a soft cloth, warm water and washing-up liquid. Polish dry with an microfibre cloth. For more stubborn marks and to protect the glass surface use a good quality glass cleaner/conditioner, following the manufacturer's instructions.

Please do not use steam cleaners on the oven interiors as this may damage electronic parts.

Ensure the cooker is cold before cleaning.

#### Removal of the oven door (without soft close hinges)

To allow full access to the inside of the oven for thorough cleaning, the oven door can be removed.

- Fully open the door and insert the pins supplied into each hinge.
- While closing the door to an angle of about 30°, lift and pull so that the door leaves the mounting. Leave pins in place.

**The rivet needs to be put into the hinge before you can remove the door.**

#### Removal of the oven door (with soft close hinges )

- Close the door to an angle of about 30°
- Lift, then close the door to an angle of about 70°
- Pull so that the door leaves the mounting.

**The rivet needs to be put into the hinge before you can remove the door.**

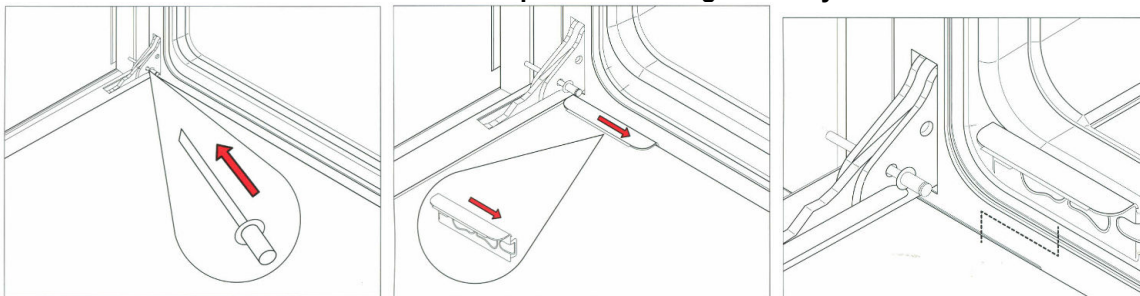

#### Removal of the inner glass door panes

To assist with cleaning, the inner glass door panes are removable.

- Open the door fully and insert the pins supplied into each hinge to secure the door in an open position.
- Locate the stainless steel clips at the base of the door.
- Slide the clips towards the centre of the door.
- Holding the glass, lift slightly and pull towards the oven, the glass pane will release.
- The central glass pane is revealed. This can be cleaned in situ or removed.
- To remove the central pane, remove the 4 screws and brackets.
- It is important to remember when replacing the central pane that the rubber spacing must be replaced first.
- When replacing the inner pane, ensure the glass is print side up and the widest border is nearest the cooker.

It is not necessary to remove the door in order to clean the glass panes.

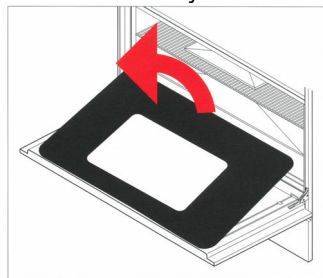

### **Oven interior**

To tell whether your oven has stay clean liners look at the oven walls. If the surface is grey in colour and rough in texture then this is a stay clean liner. If the surface is smooth and black, this is an enamelled surface.

### **Fitting the stay clean liners**

If you have purchased stay clean liners as an accessory, they are easy to fit.

#### **Sideliners**

- Remove all shelving from the oven
- Remove side shelf runners by pulling away using the centre of the bottom runner .
- Place the holes in the side of the liner over the holes in the side of the oven.
- Insert the side shelf runner into the holes starting with the top first, and then pushing in the bottom.

#### **Back liners (60cm and 90cm ovens only)**

- Place hole in centre, bottom of the liner over the hole below the fan at the Back of the oven.
- Screw into position.

### Cleaning stay clean liners

We recommend that side shelf runners, telescopic runners and shelves are removed prior to cleaning, the stay clean liners and the door and floor are cleaned by hand.

- After cooking (especially after roasting) remove all trays and shelves. Heat the oven to maximum temperature for 15 - 20 minutes to allow the stains to catalyse (true fan or fan assisted functions).
- If the oven is heavily soiled, allow the oven to cool before cleaning the splashes with a damp sponge. Then heat the oven for two hours at maximum temperature.
- Repeat the cycle if difficult marks have not been removed.
- Periodically, the side panels can be removed from the oven and washed with lukewarm soapy water before drying with a soft cloth. Before refitting the panels, clean the enamel interior.

### **Enamelled surfaces**

Do not allow vinegar, wine, coffee, milk, salt water or fruit juices to remain in contact with enamelled surfaces for prolonged periods as they may stain or discolour the surface.

For light soiling wipe with a soft cloth, using warm water and washing up liquid. For heavier soiling use a cream cleaner and a nylon scourer.

Oven cleaning products can be used according to the manufacturer's directions but care should be taken that they do not come in contact with any stainless steel, chrome, coloured or alloy parts of the cooker or the door seals and elements.

### **Side shelf runners, shelves, telescopic runners**

If lightly soiled, wipe with a soft cloth, warm water and washing up liquid. For more stubborn marks soak in warm water and washing up liquid and clean with a nylon scourer.

The side shelf runners and shelves can be cleaned In a dishwasher.

This is not advisable with the telescopic runners as the detergent may remove the lubrication on the runners.

### **Removing and refitting the telescopic runners**

- The telescopic runners fit any shelf level, and work with both the grill tray and wire shelves.
- Locate the two spring clips at the front and back of the runners.
- Gently pull down the front spring clip.
- Pull the runner away from the oven side - be careful not to strain the clip.
- Repeat steps 2 - 3 on rear spring clip to remove runner.
- To replace, hold runner level with front section of side support and clip in place. Repeat with rear section.

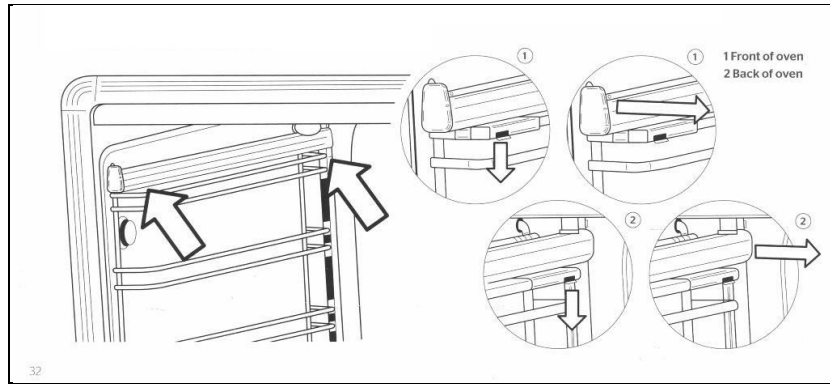

### Removal of roof tray

The roof tray above the grill element can be removed for cleaning.

- Support the grill element with one hand while removing the 2 wing nuts that hold the element in place.
- The element position will drop slightly allowing removal of the top liner.
- Once cleaned and dried, the top liner can be placed back into position, above the element, and re-secured with the two wing nuts.
- The liner will only fit into one position so care must be taken to locate it on the rear lugs and the front large lip must be facing downwards.
- Do not use the oven unless the liner is fitted and the element has been re-secured with the wing nuts.

### Removal of the soft close drawer

- Pull the drawer forward.
- Locate the grey clips behind the runners at the front of the drawer.
- Push in the clips and the drawer will release.

### Replacing the soft close drawer

- Replace the drawer on to runners and close.

## ACCESSORIES

### Plinth kits

The three-sided plinth can be screwed to the underside of your cooker to conceal the adjustable legs. The plinth is 9,3cm in height (cannot be used with extra high legs, and is not suitable for 100X60 triple oven).

### Griddle

Half flat, half ribbed griddle is perfect for searing meat, chicken and fish. Rests on pan supports of all cookers.

### Stay clean liners

These liners are easily fitted into the back and sides of all ovens (sides only in 30cm and 40cm ovens). They are treated with a special material that absorbs grease splashes during cooking. By heating the oven periodically to maximum temperature, the splashes are burnt off to keep the oven interior like new..

### Telescopic sliding shelves

Even when fully extended the telescopic system offers a safe and convenient way to grill, baste and check food without removing the trays or dishes from the oven. One set is included in the main oven of T version. Fits all ovens and works with the grill tray and shelves.

### Cast iron wok support

This accessory is placed over the pan support to use with round-bottomed woks and balti pans

### Extra high adjustable legs

These stainless steel legs increase the height of your cooker to accommodate kitchen units 91cm - 94.5cm high. (not suitable for 100X60 triple oven)

## TROUBLESHOOTING

### **The oven will not operate**

- Is there power to the cooker?
- Is the automatic programmer set to manual?
- The main oven will not operate manually if the programmer is set to automatic mode. (See page 28)
- Confirm that power is on by checking that the clock is functioning
- Check the switch fuse or circuit breaker.

### **The burners will not ignite**

- Is there power to the cooker?
- Are the ignition candles or burner holes blocked? Are the burner rings and burner caps seated firmly?
- Confirm that power IS on by checking that the clock is functioning.
- Check the switch fuse or circuit breaker.
- Check that the ignition candle is clean and the burner slots are dry and free of debris.
- The burner rings should engage in the burner support. (See page 35)

### **The burner ignites but goes out when the knob is released**

- The burners have flame failure devices fitted as standard. Therefore, after lighting the burner, keep the knob pressed in for 5-10 seconds to activate the flame failure device.

### **The ignition candles are sparking continuously**

- Is the hob wet from cleaning or a boil over?
- Turn off the electricity supply and thoroughly dry the burner components and ignition candles.

### **The control knob are getting too hot**

- Are you cooking with the oven door open?
- Keep the oven door shut when not in use or when grilling (the 100X60 triple oven separate grill compartment can be used for open door grilling for short periods only - max 15 min).

### **A control knob is loose on its shaft**

- The knob retaining spring clip may have come out.
- Call our service and spares department for advice and a replacement if necessary.

### **Food is cooking too quickly**

- Are you using a fan function?
- Are you using the Fast preheat function?
- When using a fan function you should reduce the cooking temperature by 20°C when compared to conventional cooking. Please see the cooking charts on page 33 for temperatures.

'Fast preheat' is not suitable as a cooking function; it is only for pre-heating the oven. Once the oven has reached temperature you should change over to your required cooking function. Fast preheat should not be operated for long time.

### **Food is not cooking evenly**

- Are you cooking large volumes of food or using large trays?
- Air needs to circulate through the oven for even cooking. Remove the grill pan from the oven when not in use and always allow a gap on all four sides of dishes. If cooking large quantities you may need to turn your trays during the cooking time. Oversized baking sheets, roasting pans and cake tins will act as a baffle and prevent hot air from travelling around the oven.
- Choose cooking equipment that allows a minimum of 2cm space on all sides to allow the free movement of hot air.

### **The grill in the oven is slow**

- Have you selected the correct function?
- Check that you have selected the grill function and not the top element. See page 25.

### **The main oven takes a long time to preheat**

- Have you tried using the Fast preheat function?
- Pre-heat with the Fast preheat function until the temperature has been reached, then switch to your required cooking function.
- 'Fast preheat' should not be operated for long time.
- To order spare parts or accessories, please call our service & spares department.

### **The fan continues after the oven is turned off**

- The cooling fan will run on and off intermittently for approximately 30 minutes after the oven is switched off to keep the controls cool, this is normal.

### **Condensation forms in the oven**

- Have you pre-heated the oven?
- Condensation is less likely to form when the oven or grill is pre-heated before use.

### **Smoke is generated in the oven**

- Have you selected the right cooking temperature?
- Are you cooking high fat content foods? Do you rarely use the grill?
- Have you cooked fatty foods under the grill? Does the oven interior, stay clean liners or roof tray need to be cleaned?
- Remember to reduce the oven temperature by 20°C if using a fan function with a recipe designed for conventional cooking.
- Use high sided dishes to contain fats and splashes.
- Clean the oven interior if necessary.
- Remember to remove and clean the grill pan after use.
- Leave the grill on for a few minutes after grilling or roasting to burn off fatty deposits from the oven roof.
- Oven surfaces should be cleaned regularly to prevent build-up of cooking residues. See page 35.

### **The door seal has split or perished**

- Are you leaving the grill pan or foil at the bottom of the oven?
- Have you used caustic oven cleaners on or near the door seal?
- Always remove the grill pan when not in use as it can restrict airflow around the oven.
- Caustic cleaners should not be used near the door seal area. Contact our service & spares department for advice and a replacement seal if necessary

## **USEFUL TIPS**

### **Cookshop thermometers**

- These are often slow to react and they should only be used as a guide. You should also keep in mind that oven temperatures can fluctuate between 10% and 15% during any cooking period. This is normal on any oven and is caused by the elements 'cycling' on and off.

### **Correct cooking time**

- In most cases, the cooking times stated in recipes should be used. However, the cooking period should be reduced for dishes that require very long cooking time (such as rich fruit cakes). As a guide, reduce the cooking time by 10 minutes for each hour after the first hour of cooking, or after three quarters of the way through the cooking period. This also applies to very large joints of meat or turkey where a meat thermometer is recommended. Always check that the food is hot and cooked before serving.

### **Using foil**

- Foil can be used to cover food in the oven but this should not come into close proximity with the oven elements. Foil should not be used to line the oven cavity

or grill pan This can cause overheating, buckling and cracking of the enamel surfaces.

- Silicon oven mats (sometimes used to reduce cleaning) must not be placed on the floor of the oven when the base element IS in use (e.g. when using Bottom Element only or Conventional Cooking). The silicon oven mats will damage the enamel interior.

#### **Doors and door seals**

- The fit and general state of the oven doors and seals can affect temperatures in the oven. Clean the oven seals regularly and check them for splits and tears Do not leave oven cleaning materials in prolonged contact with the seals as this will shorten their life span.

- Doors and their handles should not be used to move the cooker. This can pull the door and its hinges out of position and cause heat loss or uneven heating of the ovens.

#### **Induction cookers**

The induction hob uses a sophisticated zone management system which controls the level of power available to each of the zones to prevent over loading of the circuits and the power supply to the appliance.

The system automatically reduces the maximum power available to any one zone when the other zones are being used at the same time at a high power setting If the power level is reduced on one zone. the power can be increased on other zones.

If several zones are used on maximum power at the same time, it is possible that another zone may not operate. This can be managed by reducing the power level on one of the other zones.

As an example. Using the front left and back left zones on level 9, would not allow the middle zone to operate; this would register as an inactive zone with a line in the middle of the display. Turning the back left zone down to level 8 would allow the middle zone to operate up to level 7.

#### **100x60 triple oven levelling feet**

The cooker is equipped with 4 leveling feet that can be adjusted up or down using the Allen key supplied through the centre of the foot.

To level the cooker

Start by adjusting the rear left foot to the height of the worktop (or the final required height of the cooker) as this foot is not accessible from the front of the appliance.

Place the cooker in position. The other 3 legs are accessible from the front of the appliance. Remove the front plinth and storage drawer to access the 3 adjustable legs; use the Allen key tool through the middle of the leg to make the required height and leveling adjustments.